



Model 711 through 722, 24 volt power supply with notch-type, or viscous sensors

Ultrasonic Point Level Detector (One and Two Point)

General Instructions

The Ultrasonic Point Level Detector indicates liquid presence/absence within a sensor cavity. Two piezoelectric crystals face each other across the sensor cavity. One crystal transmits an ultrasonic signal; the other crystal receives the signal.

When the sensor cavity is empty, the receiver detects a weak signal because air is a poor conductor of ultrasonic waves. With the failsafe detector in the "HI" position, the normally open relay contacts remain open, and the Liquid Level LED is not lit.

When process liquid fills the sensor cavity, the receiver detects a strong signal because liquids are good conductors of ultrasonic waves. With the failsafe detector in the "HI" position, the normally open relay contacts are closed, and the Liquid Level LED is lit.

The Failsafe Slide Detector reverses the relay actuation. However, the liquid level LED is lit only when the relay is energized.

The sensor monitor circuitry (standard on 721 and 722 series detectors only) constantly monitors sensor integrity and opens the normally open contacts of the sensor monitor relay in the unlikely event of a sensor failure. The relay is energized when the sensor is operating properly.



NOTE: If you suspect that a product is defective, contact the factory or the SOR® Representative in your area for a return authorization number (RMA). This product should only be installed by trained and competent personnel.

Design and specifications are subject to change without notice.

For latest revision, go to www.sorfinc.net

Table of Contents

PC Board Arrangement.....	2
Sensor Installation	3-4
Electrical Connection.....	5
Sensor Monitor Connection	6
One Point Remote Cable Connection	7-8
Time Delay Adjustments	10
Pump Logic Accessory	11
PC Board Field Replacement	11
Sensor Test Procedure	13
Replacement Fuses	13
Spare Parts	13
Troubleshooting	14
Control Drawings	15-16

PC Board Arrangement

A Models beginning with 71

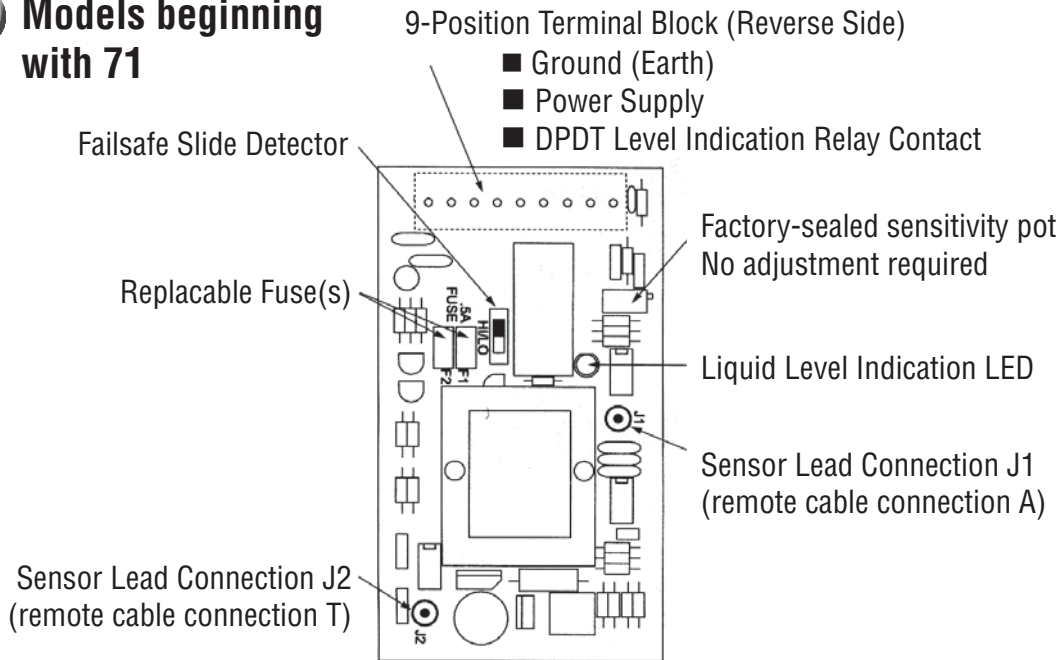

B Models beginning with 72

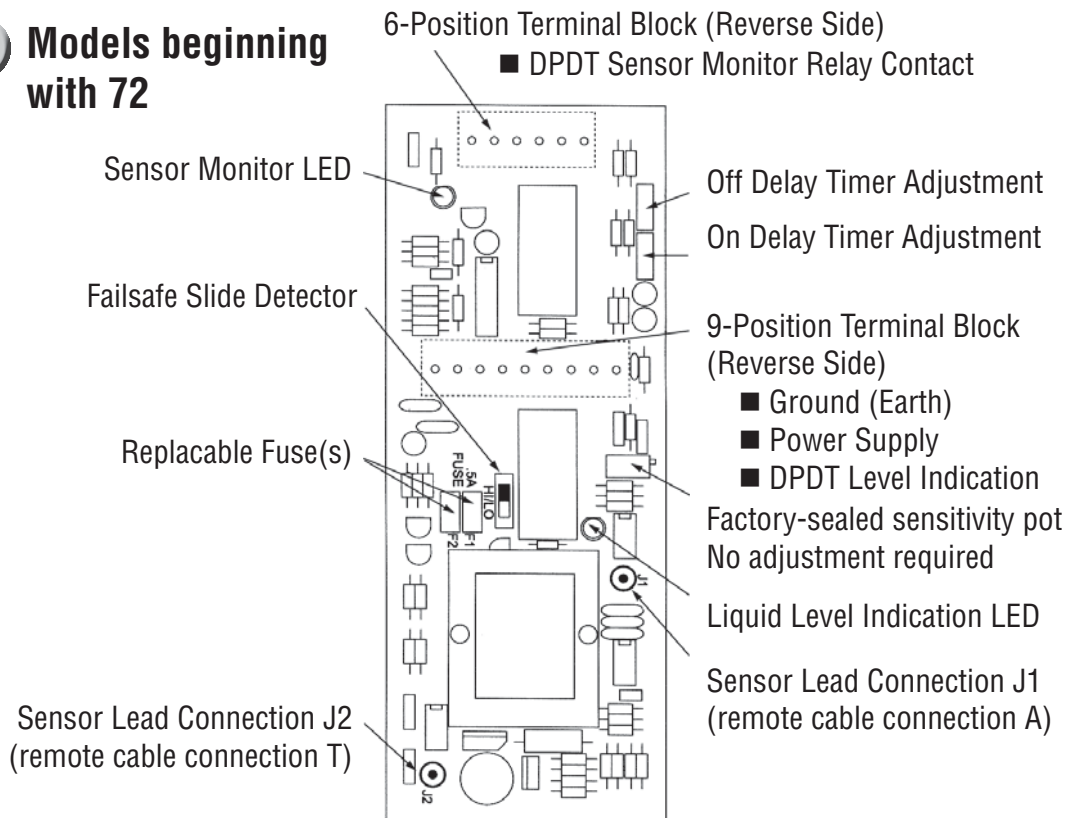

Standard 316SS and Teflon Notch-Type sensors and 316SS Viscous sensors are available for use with the point level detector. Extreme care must be taken when installing units with Teflon sensors. See installation instructions beginning on page 3. Viscous and Teflon sensors are available in one point configuration only.

Sensor Installation

Notch-Type Sensor (Series 37 □ - N)

Series 370 Ultrasonic Level Sensors can be mounted by inserting the sensor through a fitting in a vessel, or the sensor may be suspended over an open sump or basin.



DO NOT weld any part of this instrument.



Irreparable damage may be done to Teflon sensors by turning Metal hex and Teflon hex separately. Always rotate Metal hex and Teflon hex simultaneously. Do not apply more than 10 in. lbs. of torque to either hex during installation!

Tank or Vessel

Make sure that the sensor can be fully inserted and tightened without interference from obstructions inside the tank or vessel. (See **C**)

Apply suitable sealant to the process connection to prevent process leakage.

Do not use the sensor base as a handle to tighten the process connection.

One Point Horizontal Sensor Mounting (Series 371 Notch-Type)

When tightened securely, the sensor cavity must face sideways for optimum drainage when process liquid level drops below the sensor cavity.

An alignment mark X stamped on a wrench flat (or on the dry face of a flange below the housing) shows sensor cavity orientation. (See **D** and **E**)

Notch-Type Sensors — Optimum drainage occurs when the X mark is located at 3 or 9 o'clock.

The sensor must project through a tank fitting so that the sensor cavity is at least 1" beyond the inner wall of the tank. (See **D** and **E**)

C

Always turn Teflon hex & Metal hex together when installing sensor into process.

Teflon Notch Sensor (Metal sensor may vary)

Sensor Base Hub

Apply thread sealant

No Obstructions

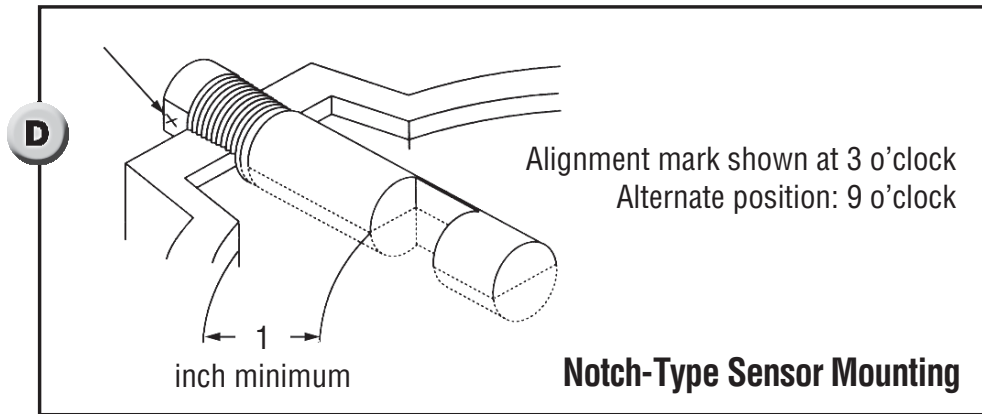

Open Sump or Basin

Do not suspend the unit by rigid conduit installed in the electrical hub. When installing the unit over an open sump or basin, use a suitable bracket to support the instrument.

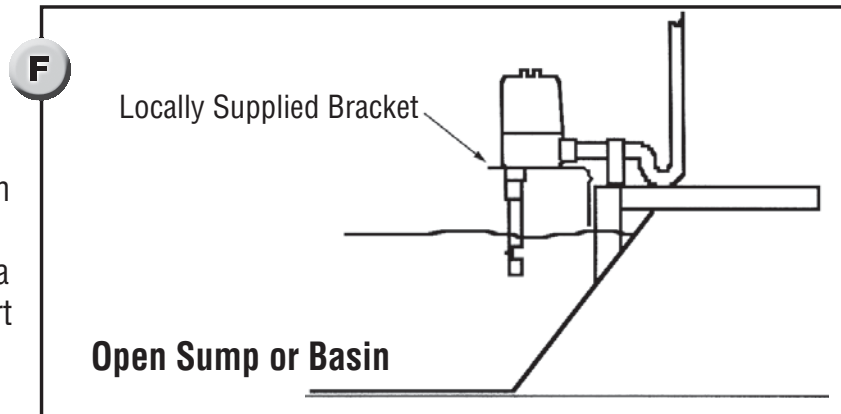

NOTE: The instrument must be positioned so that overflow does not flood electrical housing (see **F**)

Sensor Installation

Viscous Sensor (Series 371-V)

Vertical or horizontal (flange only) mounting is supported for the viscous sensor. A 3" (76.2mm) diameter minimum opening is required for insertion.

An alignment mark X stamped on the dry face of the flange below the housing shows sensor cavity orientation. (See **G**) Optimum drainage occurs when the X mark is located at 6 o'clock.



DO NOT weld any part of this instrument.

Take care during installation to prevent damage to the sensor end. Slight bending of the sensor may result in loss of sensitivity due to misalignment of the ultrasonic crystals.

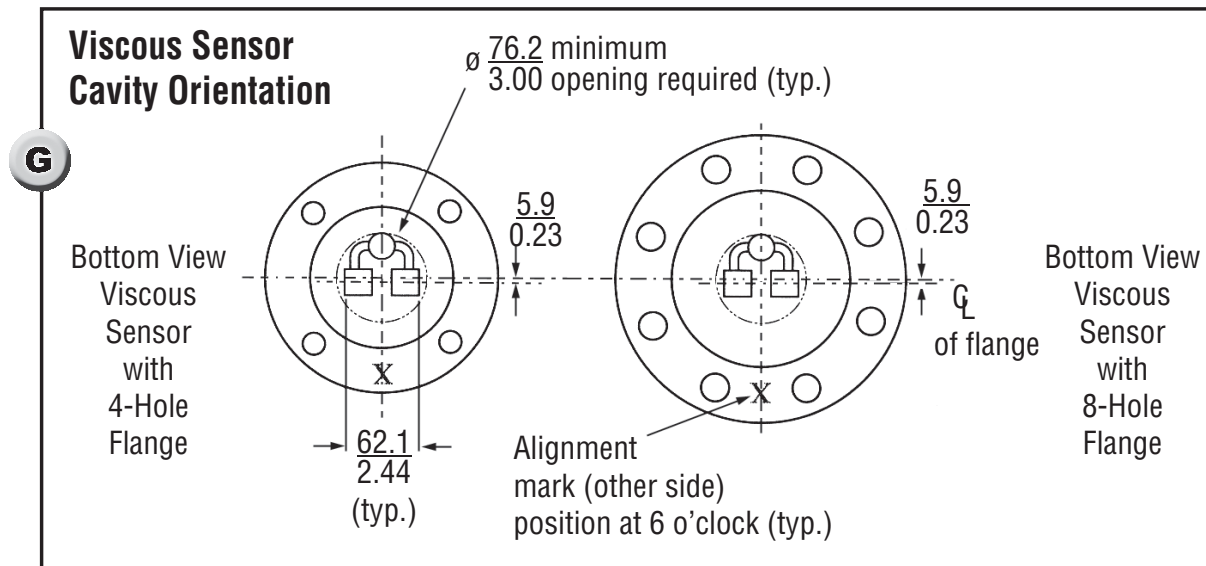

Electrical Connection



Electrical power must be disconnected from explosion proof models before the cover is removed. Failure to do so could result in severe personal injury or substantial property damage.

Ensure that wiring conforms to all applicable local and national electrical codes and install unit(s) according to relevant national and local safety codes.

A nine-position terminal strip provides connections for DPDT Liquid Level Relay Contacts, Line Power and Ground. Terminal positions are labeled on the green insulator card as shown in **H**.







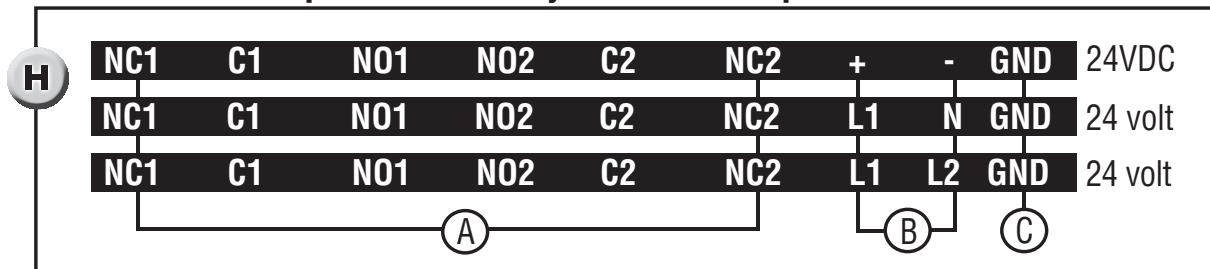

Two point sensors have twin PC boards marked “Upper” or “Lower” for their matching sensor cavities.

- A. Liquid Level Relay Contact Terminals** Before making connections to the Liquid Level Relay Contact Terminals on the nine-position terminal strip, determine the fail-safe mode best suited for the application. Locate fail-safe slide detector. (See **A** and **B**) Refer to the continuity chart for the selected fail-safe mode (**I**) when making connections to the Liquid Level Relay Contact Terminal positions. When the unit is used as an FM approved Low Water Level Limit Detector, the Fail-safe Slide Detector must be set to the HI position as shown in the upper half of **I**.
- B. Line Power Terminals** Terminals are provided for incoming power leads on the nine-position PC board terminal strip. Supply voltage for each PC board is printed on the green insulator card. Make sure that the available line voltage matches the device’s power supply.
- C. Ground Terminals** The housing and the PC Board must be connected to ground. Ground (earth) screws are provided on the nine-position PC board terminal strip and on the housing floor. If extra clearance is required for connection to the ground screw on the housing floor, the PC board can be removed and reinstalled according to PC Board Field Replacement on page 11.

Nine-Position Liquid Level Relay Terminal Strip

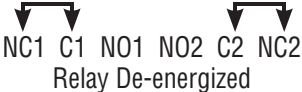

Relay Continuity Chart



I Fail-safe Mode Detector Position	Sensor Condition	Liquid Level Relay Contact A Continuity Chart
	Liquid above sensor 	 Relay Energized
	Liquid below sensor 	 Relay De-energized
	Liquid above sensor 	 Relay De-energized
	Liquid below sensor 	 Relay Energized

Sensor Monitor Connection - Models 721 and 722 only

Any loss of the physical or electrical ultrasonic sensor integrity causes instantaneous de-energizing of the DPDT sensor monitor relay. (See **J**) Two point sensors have one sensor monitor relay for each sensor cavity.

A six-position terminal strip provides connections for each set of DPDT sensor monitor relay contacts. Terminal positions are labeled on the green insulator card(s).

The sensor monitor is continuously on duty whenever the instrument is powered. It does not require external initiation and it is not initiated at programmed intervals. If the sensor monitor indicates a fault, see Troubleshooting on page 14.

J Sensor Status	Sensor Monitor Relay Contact Continuity Chart
Functioning	 Relay Energized
Sensor/Electronics Malfunction Loss of Power Supply	 Relay De-energized

One Point Remote Cable Connection - Models 711R1 and 721R2 Only

Install conduit between the sensor base and the electronics housing to provide a raceway for sensor extension cables. (See **K**) The sensor base and the electronics housing are suitable for use in Class I Groups C & D; Class II Groups E, F & G; Divisions 1 & 2 hazardous locations. All conduit and fittings used for the installation must equal or exceed this rating to maintain the explosion proof integrity of the assembly.

Ensure that wiring conforms to all applicable local and national electrical codes and install unit(s) according to relevant national and local safety codes.

Fishing the Sensor Extension Cables

Two sensor extension cables are supplied. Both ends of the cables are terminated and labeled at the factory.

Use care to avoid damaging the factory installed coax connectors while fishing the sensor extension cables through the conduit. Pull cables from the sensor base so that the free ends follow the fish through the conduit. (See **K**)

Leave enough cable in the electronics housing to make PC board connections.

Sensor Coax Connections Inside Sensor Base

Inside the sensor base, the remote interconnect board rests in a plastic holder. Slide the interconnect board up.

Attach the extension cables to the interconnect board as follows:

- Connect the long sensor cable (A) to IN 1.
- Connect the short sensor cable (T) to IN 2.

Attach the extension cables to the interconnect board as follows:

- Connect cable A to OUT 1.
- Connect cable T to OUT 2. (See **M**)

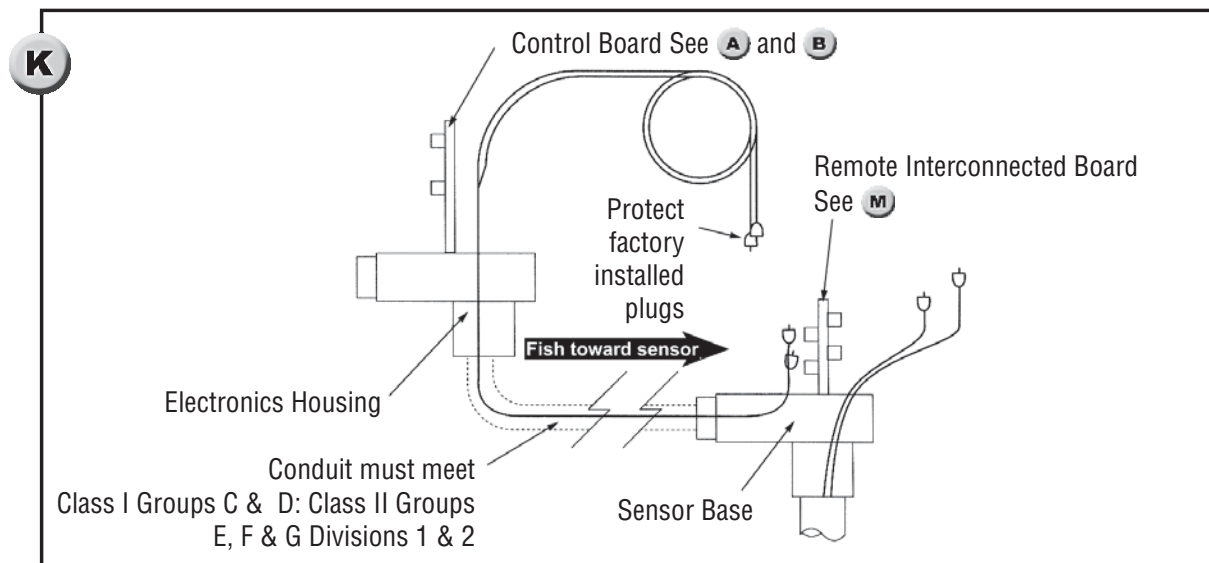

Discharge the Sensor

Temperature changes which occur during shipment may result in a small electrical charge inside the sensor crystals. This charge is harmless to humans, but may result in damage to the electronics if the sensor is plugged in before it is discharged. To discharge the sensor, touch a wire to each sensor connector so that the center conductor and outside shell make contact. (See **L**)

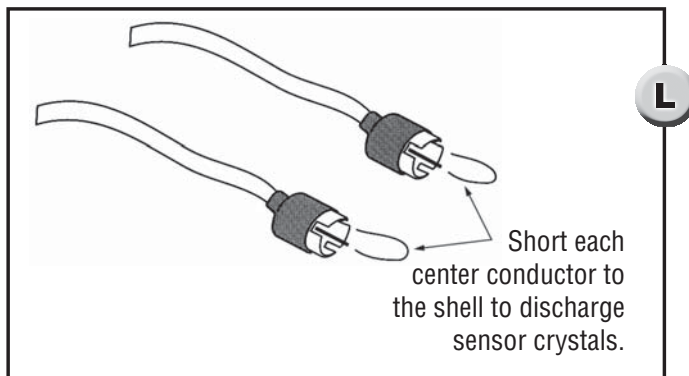

Plug in Connections Inside Electronics Housing

Plug sensor extension cables onto the PC board as follows:

Connect cable A to J1.

Connect cable T to J2. (See **A** and **B**)

Power to the electronics must be disconnected before removing the cover of the sensor base in a hazardous area.

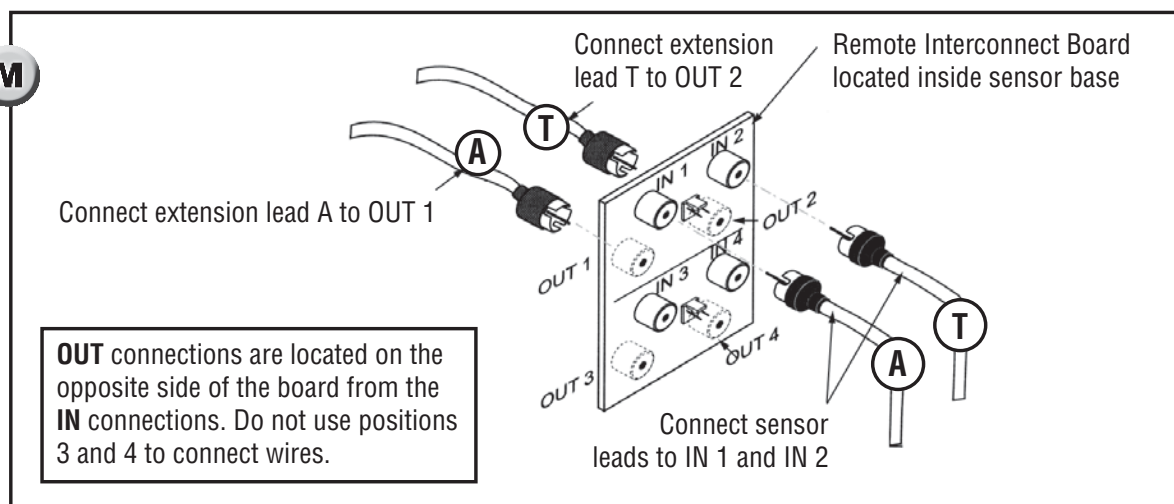

One Point Remote Cable Connection - Models 711R1 and 721R2 Only

Install conduit between the sensor base and the electronics housing to provide a raceway for sensor extension cables. (See **N**) The sensor base and the electronics housing are suitable for use in Class I Groups C & D; Class II Groups E, F & G; Divisions 1 & 2 hazardous locations. All conduit and fittings used for the installation must equal or exceed this rating to maintain the explosion proof integrity of the assembly.

Ensure that wiring conforms to all applicable local and national electrical codes and install unit(s) according to relevant national and local safety codes.

Fishing the Sensor Extension Cables Three sensor extension cables are supplied. Both ends of the cables are terminated and labeled at the factory.

Use care to avoid damaging the factory installed coax connectors while fishing the sensor extension cables through the conduit. Pull cables from the sensor base so that the free ends follow the fish through the conduit. (See **N**) Leave enough cable in the electronics housing to make PC board connections.

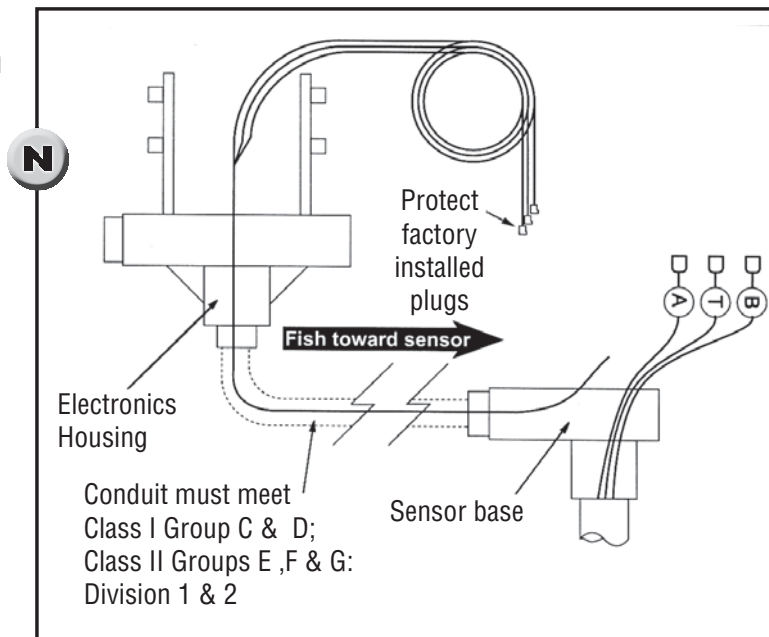

Coax Connections Inside Sensor Base

Inside the sensor base, a remote interconnect board rests in a plastic holder. Slide the interconnect board up. Attach the sensor coax connectors to the interconnect board as follows (See **O**):

- Connect cable A to IN 1. [Sensor cavity A (upper) receiver crystal]
- Connect cable B to IN 3. [Sensor cavity B (lower) receiver crystal]
- Connect cable T to IN 2. (Transmitter crystals)

Attach the extension cables to the interconnect board as follows:

- Connect cable A to OUT 1.
- Connect cable B to OUT 3.
- Connect cable T to OUT 2.

Avoid mismatched connections which could render the unit inoperative.

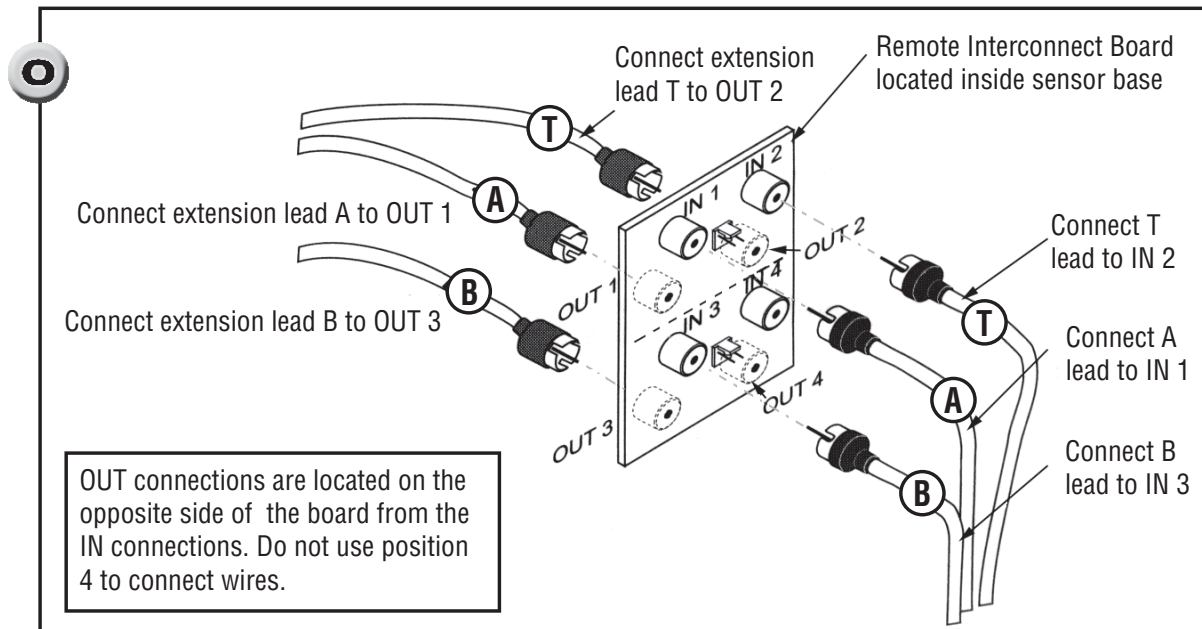

Plug in Connections Inside Electronics Housing

Discharge the sensor per instructions on page 8. Attach the PC board connectors according to Figure **P**. Note that cable T can be connected to J2 on either the upper or the lower PC Board.

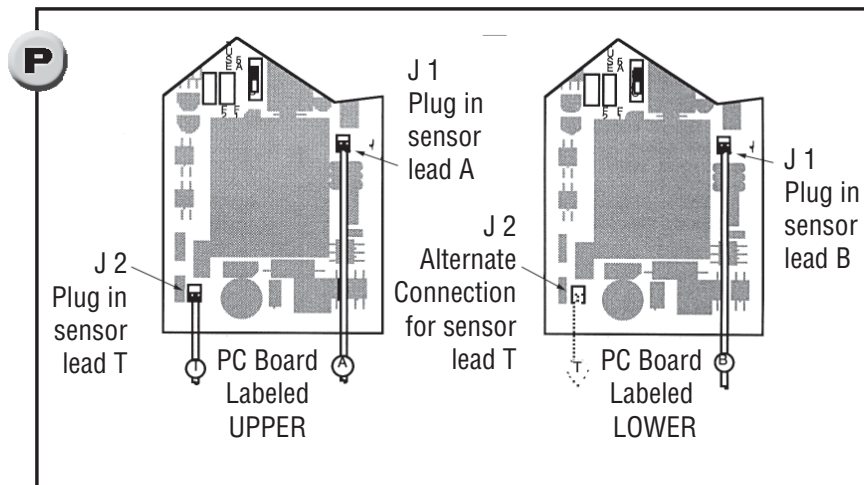

Electrical power must be disconnected from explosion proof models before the cover is removed. Failure to do so could result in severe personal injury or substantial property damage.

Time Delay Adjustments — Models 721 and 722 only

On Delay Timer Adjustment

On delay is an integral timer that starts when process liquid is detected in the sensor cavity. Two point sensors have an On Delay timer for each sensor cavity. If the liquid level falls before the On timer completes its cycle, the timer resets to zero and waits for the sensor cavity to fill again. When the On timer completes its cycle, the liquid level relay changes state to indicate liquid level is above the sensor.

Fully clockwise — 0-second delay

Fully counterclockwise — approximately 30-second delay

Off Delay Timer Adjustment

Off delay is an integral timer which starts when the liquid level falls. Two point sensors have an Off Delay Timer for each sensor cavity. If the sensor cavity is refilled before the Off timer completes its cycle, the timer resets to zero and waits for the sensor cavity to be emptied again. When the Off timer completes its cycle, the liquid level relay changes state to indicate liquid level is below the sensor.

Fully clockwise — 0-second delay

Fully counterclockwise — approximately 30-second delay

Pump Logic Accessory — Models with PL near the end of the Model Number

Two point ultrasonic level detectors with the PL accessory are supplied with a third PC board that has a DPDT relay for pump logic control. This third board is factory wired to one set of liquid level relay contacts on each sensor cavity PC board. (The unwired set of SPDT contacts on each sensor cavity PC board can be used for High and Low level alarms or other external devices.)

The DPDT Pump Logic Relay can be field set to pump up or pump down according to the drawing below. The two pump modes are details in the drawings here.

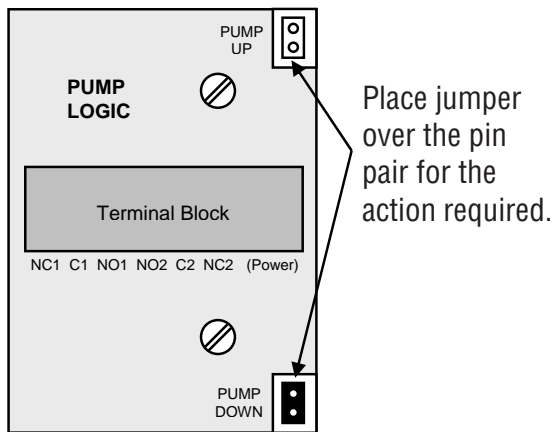

Pump Mode	Sensor Condition	Liquid Level Relay Continuity Chart
Pump Up Mode	High Level	 NC1 C1 NO1 NO2 C2 NC2 Relay De-energized
	Low Level	 NC1 C1 NO1 NO2 C2 NC2 Relay Energized
Pump Down Mode	High Level	 NC1 C1 NO1 NO2 C2 NC2 Relay Energized
	Low Level	 NC1 C1 NO1 NO2 C2 NC2 Relay De-energized

PC Board Field Replacement — See page 14 for ordering information



Electrical power must be disconnected from explosion proof models before the cover is removed. Failure to do so could result in severe personal injury or substantial property damage.

- A. Remove the electronics housing cover.
- B. Note existing connections then disconnect all conductors from the PC board terminal strips. Continue according to one or two point instructions:

One Point Sensors (711 or 721)

- ① Remove the two screws to release the PC board bracket from the housing.
- ② Slide the PC board straight up, then unplug the sensor cables from the PC board.
- ③ Slide the old PC board completely out of the housing.
- ④ Slide the new PC board into the PC board mounting slots.
- ⑤ Discharge the sensor per instructions on page 8.
- ⑥ Plug sensor cable A into J1 on the new PC board.
- ⑦ Plug sensor cable T into J2 on the new PC board.

- ⑧ Reinstall the two screws to secure the PC board bracket to the housing.
- ⑨ Go to C.

Two Point Sensors (712 or 722)

Upper and lower sensor cavities are connected to dedicated PC Boards. The PC boards are marked Upper and Lower to indicate which board belongs to which sensor. One or both of the boards can be replaced.

To replace the Upper board:

- ① Unscrew the three 1-1/2" #4 mounting screws which fasten the Upper board to the housing mounting bracket. (Note spacer locations.) Unplug sensor cable A. If sensor cable T is plugged into J2 on the Upper board, unplug it. If there is no connection to J2 on the Upper board, skip step 4.
- ② Discharge the sensor per instructions on page 8.
- ③ Plug sensor cable A into J1 on the new Upper PC board.
- ④ Plug sensor cable T into J2 on the new Upper PC board.
- ⑤ Restack the spacers and replace the three 1-1/2" #4 mounting screws.
- ⑥ Go to C.

To replace the Lower board:

- ① Unscrew the three 1-1/2" #4 mounting screws which fasten the Lower board to the housing mounting bracket. (Note spacer locations.) Unplug sensor cable B. If sensor cable T is plugged into J2 on the Lower board, unplug it. If there is no connection to J2 on the Lower board, skip step 4.
- ② Discharge the sensor per instructions on page 8.
- ③ Plug sensor cable B into J1 on the new Lower PC board.
- ④ Plug sensor cable T into J2 on the new Lower PC board.
- ⑤ Restack the spacers and replace the three 1-1/2" #4 mounting screws.
- ⑥ Go to C.

C. Reconnect all conductors to the PC board terminal strips.

D. Replace the cover.

E. Restore power to supply and control circuits. Conduct functional test.

Sensor Test Procedure

- ① Disconnect a sensor cable from the PC board. Measure the capacitance across the pin and shell of the male mini phono connector.
 - Capacitance from 600 to 1500pf indicates circuit is good. Plug the sensor cable back into the PC board. Go to step 2. See note below for epoxy sensor capacitance values.
 - Capacitance lower than 600pf or higher than 1500pf indicates that the circuit is bad. For remote units, go to Step 1a. Otherwise, go to Step 3.
- a. Disconnect a sensor cable from the remote interconnect board inside the sensor base. Measure the capacitance across the pin and shell of the male coax connector.
 - Capacitance lower than 600pf or higher than 1500pf indicates that the sensor is bad, go to step 3.
 - Capacitance from 600 to 1500pf indicates sensor is okay; the fault may be in the extension cable. Replace the extension cable. Repeat step 1 to test the new cable.
- ② Repeat step 1 for the rest of the sensor cables.
- ③ A replacement sensor can be ordered from the factory or the SOR representative in your area. Required order information: model and serial numbers stamped on the sensor nameplate.

Replacement Fuses

Find a match for the control model number stamped on the housing nameplate in one of the boxes below. Ignore characters which fall in a space. Order from the box containing the model number match.

SOR part numbers can be ordered from the factory or from the factory representative in your area. Buss and Wickmann part numbers can be ordered from third party suppliers.

See page 1 for fuse location(s).

7 <input type="checkbox"/> <input type="checkbox"/> <input type="checkbox"/> <input type="checkbox"/> - <input type="checkbox"/> -P6- <input type="checkbox"/>		
SOR part number	2806-006	
Wickmann part number	19374K	(1/2 slow blow)

7 <input type="checkbox"/> <input type="checkbox"/> <input type="checkbox"/> <input type="checkbox"/> - <input type="checkbox"/> -P7- <input type="checkbox"/>		
SOR Part number	2806-003	
Buss part number	PCB1/2A	(1/2A fast acting)

7 <input type="checkbox"/> <input type="checkbox"/> <input type="checkbox"/> <input type="checkbox"/> - <input type="checkbox"/> -P8- <input type="checkbox"/> *		
SOR Part number	2806-003	
Buss part number	PCB1/2A	(1/2A fast acting)

*Requires two fuses

Spare Parts

To order the correct PC board for a particular instrument, find a match for the nameplate model number in the left column below. Ignore characters which fall in a space. Order a part number from the column to the right of the model number. Include the serial number of the instrument to ensure receipt of the proper board revision.

Model No. of 1 pt control for metal notch integral sensor	Replacement Board includes hardware	Model No. of 1 pt control for metal notch remote sensor	Replacement Board includes hardware	Model No. of 1 pt control for viscous sensor	Replacement Board includes hardware
711K1-N-P6-C	5002-996	711R1-N-P6-C	5002-958	711K1-V-P6-C	5003-021
711K1-N-P7-C	5002-997	711R1-N-P7-C	5002-959	711K1-V-P7-C	5003-022
711K1-N-P8-C	5002-998	711R1-N-P8-C	5002-960	711K1-V-P8-C	5003-023
721K2-N-P6-C	5002-999	721R2-N-P6-C	5002-961	721K2-V-P6-C	5003-024
721K2-N-P7-C	5003-001	721R2-N-P7-C	5002-962	721K2-V-P7-C	5003-025
721K2-N-P8-C	5003-002	721R2-N-P8-C	5002-963	721K2-V-P8-C	5003-026
Model No. of 2 pt control for metal notch integral sensor	Replacement Board includes hardware	Model No. of 2 pt control for metal notch remote sensor	Replacement Board includes hardware	Model No. of 1 pt remote control for viscous sensor	Replacement Board includes hardware
712K3-N-P6-C	5003-003	712R3-N-P6-C	5002-964	711R1-V-P6-C	5003-015
712K3-N-P7-C	5003-004	712R3-N-P7-C	5002-965	711R1-V-P7-C	5003-016
712K3-N-P8-C	5003-005	712R3-N-P8-C	5002-966	711R1-V-P8-C	5003-017
722K3-N-P6-C	5003-006	722R3-N-P6-C	5002-967	721R2-V-P6-C	5003-018
722K3-N-P7-C	5003-007	722R3-N-P7-C	5002-968	721R2-V-P7-C	5003-019
722K3-N-P8-C	5003-008	722R3-N-P8-C	5002-969	721R2-V-P8-C	5003-020

Troubleshooting

NOTE: Agency certified units, (FM, CSA, IEC) must be returned to SOR for repairs.

Symptom	Possible Causes	Solutions
Sensor Monitor relay de-energized (Model 721, 722 only)	No power to unit	Restore power.
	One or both sensor coax cable(s) unplugged from PC board. Check sensor housing on remote units.	Replug coax cables into the board according to the Field Replacement procedure (page 11).
	Internal or external damage to sensor. Sensor damage can be verified using sensor test procedure (page 13). If sensor tests okay, replace circuit board according to field replacement procedure (page 11).	Replace entire instrument or contact factory for replacement sensor. The factory will request model and serial numbers to provide replacement sensor.
No response to liquid level	No power to unit	Restore power.
	Blown fuse	Replace fuse (page 13)
	One or both sensor cable(s) unplugged from PC board. Check sensor housing on remote units.	Replug sensor cables into the board according to the Field Replacement procedure (page 11).
	Internal or external damage to sensor. Sensor damage can be verified using sensor test procedure (page 8). If sensor tests okay, replace circuit board according to field replacement procedure (page 11).	Replace entire instrument or contact factory for replacement sensor. The factory will request model and serial numbers to provide replacement sensor.

Control Drawing

DRAWING NO. 9065-124

SENSOR/ELECTRONICS COMBINATIONS	
ELECTRONICS	SENSOR
701	371U
711	371N OR 371G
721	371N OR 371G
712	372N
722	372N

NOTE:

1. ONLY THOSE SENSOR/ELECTRONICS COMBINATIONS LISTED ABOVE ARE VALID.
2. SENSOR/ELECTRONICS COMBINATION IS CERTIFIED FOR THE LESSER HAZARDOUS LOCATION RATING OF THE SENSOR OR THE ELECTRONICS HOUSING. FOR EXAMPLE THE ASSEMBLY OF A GROUP B SENSOR WITH A GROUP C HOUSING IS CERTIFIED FOR GROUP C.
3. WIRING SHALL BE INSTALLED IN COMPLIANCE WITH APPLICABLE CSA EXPLOSION PROOF STANDARDS FOR HAZARDOUS LOCATIONS.

THIS DRAWING NOT TO BE CHANGED WITHOUT CSA APPROVAL.

<p>TITLE</p> <p style="text-align: center;">INSTALLATION DRAWING CSA PROBE/ELECTRONICS COMBINATIONS</p>	<p>BY</p> <p style="text-align: center;"><i>WDC</i></p>	<p>DATE</p> <p style="text-align: center;">6/7/96</p>	<p>DRAWING NO.</p> <p style="text-align: center;">9065-124</p>	<p>REV</p> <p style="text-align: center;">2</p>
<p>1</p>	<p>APPD</p> <p style="text-align: center;"><i>ae</i></p>	<p>DATE</p> <p style="text-align: center;">6/7/96</p>	<p>SHEET 1 OF 1</p>	

Control Drawing

DRAWING NO. 9065-125

SENSOR/ELECTRONICS COMBINATIONS	
ELECTRONICS	SENSOR
701	371U
711	371N
721	371N
712	372N
722	372N

NOTE:

- ONLY THOSE FMRC APPROVED SENSOR/ELECTRONICS COMBINATIONS LISTED ABOVE ARE VALID.
- SENSOR/ELECTRONICS COMBINATION IS CERTIFIED FOR THE LESSER HAZARDOUS LOCATION RATING OF THE SENSOR OR THE ELECTRONICS HOUSING. FOR EXAMPLE THE ASSEMBLY OF A GROUP B SENSOR WITH A GROUP C HOUSING IS CERTIFIED FOR GROUP C.
- WIRING SHALL BE INSTALLED IN COMPLIANCE WITH THE NATIONAL ELECTRIC CODE FOR HAZARDOUS (CLASSIFIED) LOCATIONS. SUITABLE LISTED SEAL FITTINGS SHALL BE INSTALLED WITHIN 18" OF EACH ENCLOSURE ENTRANCE.
- A MINIMUM OF 5 FULL THREAD ENGAGEMENT BETWEEN ALL NPT THREAD JOINTS AND BETWEEN PROBE AND HOUSING CONNECTIONS IS REQUIRED PER NEC.

THIS DRAWING NOT TO BE CHANGED WITHOUT FM APPROVAL.

1	EO-3771	BY WDE	DATE 12/19/96	DRAWING NO 9065-125	REV 2
2	EO-3929	APPD JUC	DATE 12/19/96	SHEET 1 OF 1	



Printed in USA

www.sorinc.net

14685 West 105th Street, Lenexa, KS 66215 ■ 913-888-2630 ■ 800-676-6794 USA ■ Fax 913-888-0767

16/16 Registered Quality System to ISO 9001:2008

Form 829 (09.11) ©2011 SOR Inc.