



# echosonix® U11 Loop Powered Transmitter

## General Instructions

The U11 is a non-contact ultrasonic level-sensing device that operates from loop power. It provides the following features for easier customer installation and operation:

- Rugged, industrial design with cast aluminum explosion proof housing
- Easy to use, plain English menus
- All values entered in engineering units
- 4-20mA signal may easily be reversed to 20-4mA
- Actual 4 and 20mA endpoints may be fine tuned
- Choice of echo types – first, last and largest
- Automated echo recognition for minor false echoes
- Bin mapping to eliminate major false echoes

These instructions provide information for mounting, process and electrical connections and field programming of the U11 loop powered ultrasonic transmitter. The U11 incorporates a transducer for sending and receiving an ultrasonic signal and an electronics processing package. The ultrasonic signal is very powerful and may cause hearing damage – refer to the safety instructions on page 2. The electronics package is mounted on top of the transducer via a permanent mechanical connection.



**NOTE: If you suspect that a product is defective, contact the factory or the SOR® Representative in your area for a return authorization number (RMA). This product should only be installed by trained and competent personnel.**

### Table of Contents

Safety .....	2
Quick Start Installation Guide.....	2
Mounting the Transducer .....	4
Typical Mounting Guidelines.....	4
Installation on Solids .....	5
Wiring Instructions .....	6
Keypad Interface .....	7
LCD Display.....	8
Field Programming .....	9
User Defined Values .....	10
Menu Structure .....	12
Dimensions .....	14
Specifications .....	16
Troubleshooting .....	16

*Design and specifications are subject to change without notice.*

*For latest revision, go to [www.sorinc.com](http://www.sorinc.com)*

## Safety

Prior to installation, review these instructions entirely. Transducer mounting location is critical to proper operation. Most settings can be programmed prior to installation.

### Electrical Safety

The U11 is an electrically powered transmitter. Common electrical safety procedures must be followed when working with this equipment. All wiring should be per local and national standards. Do not open the cover on an energized unit in an explosion proof atmosphere. Do not handle circuit boards when energized.

### Sound Protection

The U11 produces intense sound pulses. SOR recommends checking local safety standards for applicable hearing protection regulation.

Do not aim the transducer of an operating U11 at anyone's head. Permanent hearing damage may result. Use proper hearing protection when using in an enclosed space.

### Electrostatic Discharge (ESD) Handling Procedure

Our electronic instruments are designed to the highest quality standards. These products use highly sensitive electronic components that are affected by static electricity, which is present in most work environments. The following procedure is recommended to reduce the possibility of component failure caused by static electricity damage.

- Use a grounded wrist strap when installing or removing electronic boards. A grounded workstation is recommended.
- Ensure that all electrical connections are made and none are partial or floating. Ground all equipment properly.

## Quick Start Installation Guide

- 1 Install the transducer away from obstructions. It should not be mounted in the center of domed or conical roof tanks. See page 4 for minimum mounting distance from tank walls.

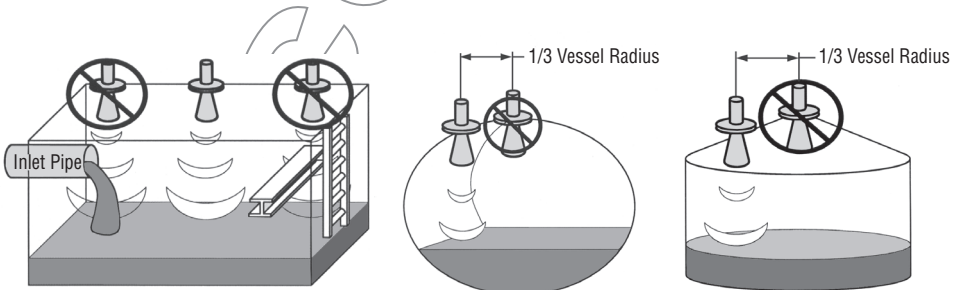

- 2 Wire the unit according to local and national safety codes. Power and signal wiring must be run as a minimum. Refer to page 6 for more wiring details.

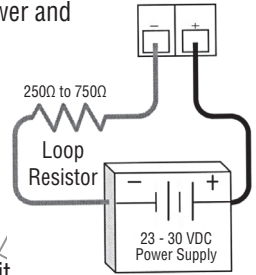

- 3 Determine the values to be entered when programming the unit. Calculate all high and low levels as the distance from the transducer down to the target point.

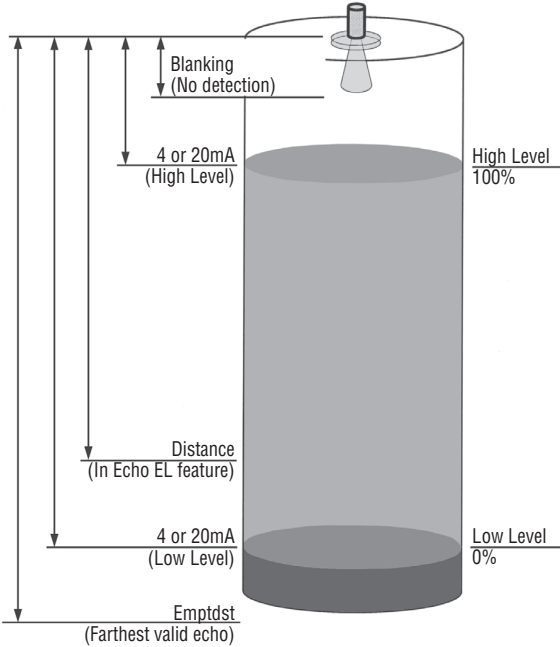

**NOTE: All values measured and entered as a distance from the top down.**

- 4 Program the basic parameters in the Setup menu. Press CAL to access the Setup Menu. See page 8 for details of the LCD display menu items and customer values.

**NOTE: To change number values fast, hold down the arrow key.**

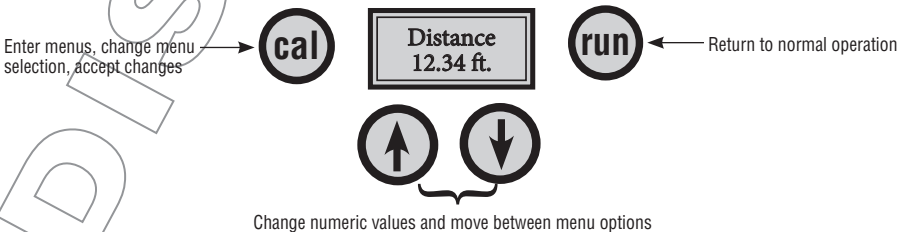

## Mounting the Transducer

Transducer mounting is critical. The transducer assembly both generates the sound pulse and monitors the echoes. The ultrasonic pulses travel away from the face of the transducer in a cone-shaped pattern. This area should be free of obstructions and away from inlets. The assembly should be in a position that allows unobstructed access between the transducer face and the process to be measured.

**Mount transducer away from inlets and obstructions**

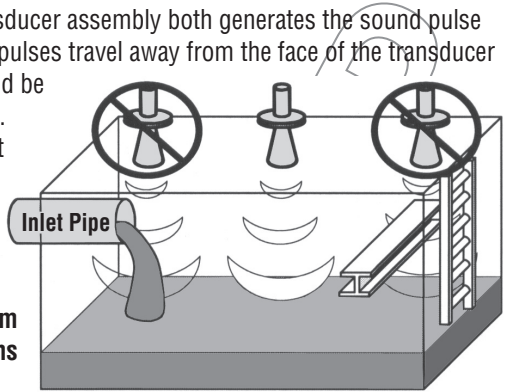

## Enclosed Vessels

Tank geometry must be considered when mounting the transducer. Certain types of vessels may create secondary echoes if the transducer is not mounted correctly. The problem is primarily with spherical vessels. This shape can refocus spent echoes and cause false readings. Mounting the transducer in a location that minimizes this effect can eliminate the problem.

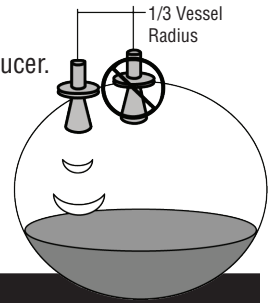

## Typical Mounting Guidelines

The transducer may be mounted using either a flange or the standard 3" NPT fitting. Whether the unit is mounted on a flange or by threads, and whether it has a focusing cone option or not, the end of the transducer assembly should always be mounted past the end of the process connection assembly. The figures below illustrate proper mounting.

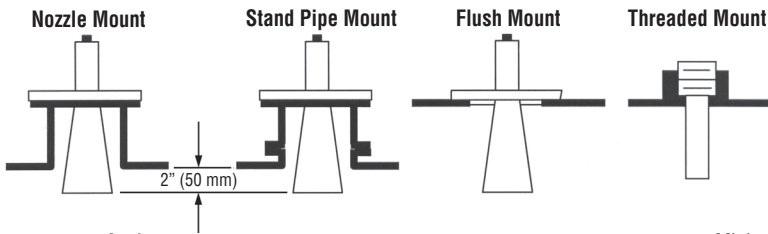

## Minimum Mounting Distance

The transducer should be mounted so that the primary cone of sound does not intersect the wall of the vessel. For best performance the transducer should be mounted outside the "Minimum Mounting Distance" shown below. When this is not possible, consult the factory for recommendations. If the distance to the sidewall is less than the "Minimum Mounting Distance" then the unit may not be able to track the process properly.

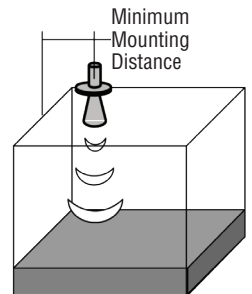

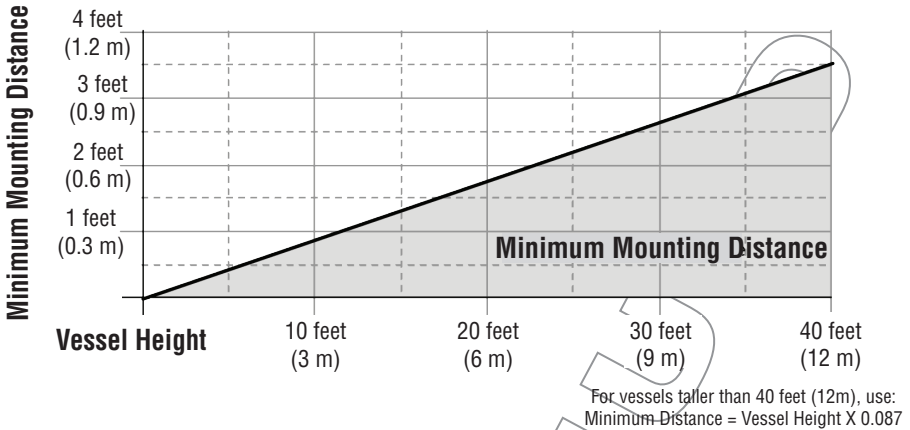

### Installation on Solids

The U11 is able to reliably read solids from any angle of repose and through dusty conditions. The transducer should be mounted in a vertical position according to the guidelines below. SOR does not recommend aiming the transducer unless absolutely required for the process, or special measurement is required as seen below.

In solids applications the transducer is typically mounted 1/3 of the distance from the wall to its center. As solids pile up they form a cone. Mounting the transducer in the position shown below gives a rough average of what the level would be if the surface were flattened out. This is true for both conical piles and pits (created when material is drawn from the bottom).

This mounting only holds true for round, cylindrical vessels with a center inlet. In other shape vessels or where the inlet is offset the transducer should be mounted according to the user's requirements.

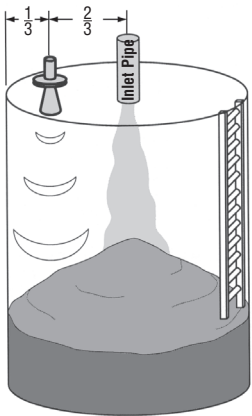

**Mount the transducer 1/3 of the vessel radius in from the wall. Mount away from inlet pipes, ladders, or other intrusions that may create false echoes.**

**Transducer should be mounted vertical pointing down towards the process.**

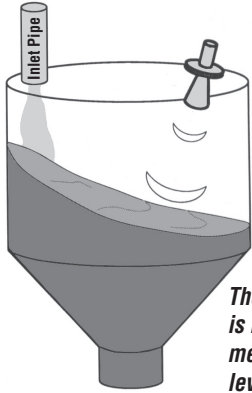

**The transducer needs to be aimed at the outfeed if level measurement is required to the bottom of the vessel. The user must be aware that the measured distance will be longer than the actual distance to the process level due to the angle of aiming.**

## Wiring Instructions

The U11 transmitter is powered by a 24VDC loop circuit. The most common method of powering the unit is from a self-powered DCS/PLC card.



***The U11 is an electrically powered transmitter. Common electrical safety procedures must be followed when working with this equipment. All wiring should be per local and national standards. Do not open the cover on an energized unit in an explosive atmosphere. Do not handle circuit boards when energized.***

- 1 Remove the display board by removing the three screws around its outer perimeter. DO NOT remove the four screws at the corners of the LCD display. Move the display out of the way.
- 2 String the wires through the electrical connections and seal connections properly.
- 3 Attach wires by pressing down on the small plastic lever while pushing the bare wire end into the terminal socket.

### Wiring Diagram

The terminal block positions are labeled per the diagram below. Polarity must be observed when wiring the U11.

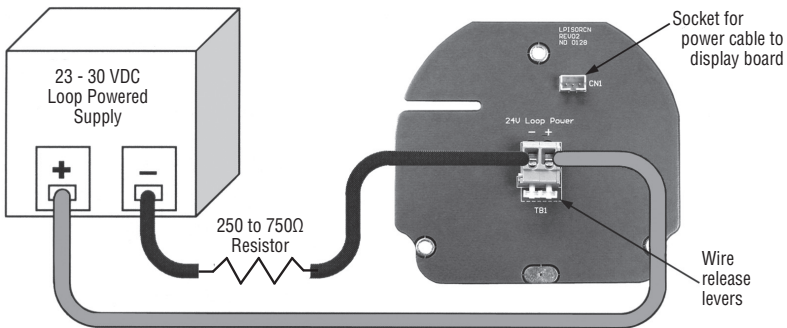

## Keypad Interface

The U11 does not require calibration, but it does require customer setup for each installation. The units, display type, high and low levels must be set as a minimum. Other parameters may be required or desired for your specific application. See Menu Structure on pages 12 & 13 for detailed descriptions of parameter setup.

All setup is done through the four-button display panel. The diagram below shows the buttons and describes their function. The display panel also includes an indicator light for the sensing pulse to verify operation of the unit.

**NOTE: When changing numerical values, hold down the arrow button to make the value change faster. The longer the button is held, the faster the value will change. Release the arrow button and press again to return to normal rate of change.**

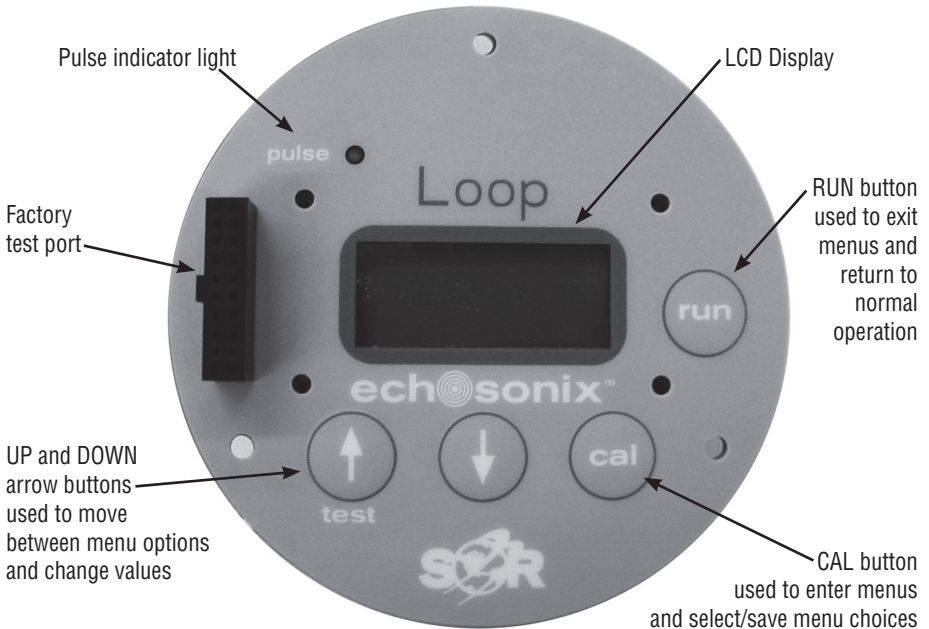

## LCD Display

Every U11 comes with 2-line 16-character LCD display. This serves as a display of process level and an interface for setting up the unit. There are three LCD display modes: normal operation, troubleshooting and programming.

### Normal Operation

In normal operation the top line of the LCD shows the Material Display Mode selected in the menu setup - Space or Material %. The second line displays the actual level status. The unit can always be returned to normal operation by pressing the RUN button.



Level  
26.83f

Normal Operation screen - display type on top line, level reading on bottom line.



Level  
28,70f

When the decimal changes to a comma, the U11 has lost echo and is trying to recover it.

#### INDICATOR

. (Decimal)  
, (Comma)  
: (Colon)

#### MEANING

Normal operation  
Recover mode – echo lost  
Hold Mode – false echo found outside of window

### Programming Mode

In programming mode the top line of the display indicates what feature is being programmed. The bottom line shows the current choice for that feature. Move from feature to feature using the arrow keys and press CAL to select and change that feature.



EngUnits  
Feet

Programming feature shown on top line, user choices/values shown on bottom line.

### Troubleshooting Mode

When the unit is in normal operation, troubleshooting information is displayed by pressing the up arrow key. The top line of the LCD changes to the troubleshooting information, the lower line continues to display the level reading.



Gn 9%  
26.80ft

Troubleshooting data displayed on top line, level reading on bottom line.





## Field Programming

The U11 menus are accessible through the four-button keypad on the display board. Information is displayed on the 2-line LCD, with the program feature shown on the top line and the current setting displayed on the bottom line. All button functions are consistent for all models and menus.



**Units in Hazardous Locations – Prior to programming, make sure that the work area is declassified before removing the explosion proof cover to program the unit. Failure to do so could result in severe personal injury or substantial property damage.**

The  and  arrow buttons are used to change user values and move between menu items. When changing numeric values, hold the arrow button down and the values will change faster the longer it is held. When the button is released and pressed again the numbers will change at a slower rate.



### “CAL” Button

The CAL button is used to enter the menus and select menu options to change. Press CAL from normal operation to enter the password screen. Enter the password using the arrow keys (factory default is 0) and press CAL to go to the menus. When the proper menu item is selected using the arrow buttons, press CAL again to access that feature and make changes.



### “RUN” Button

The RUN button returns the unit to normal operation mode. This button will exit the menus at any point, saving the current selected options and entering normal operation using all changes made in the menus.

## User Defined Values

Several user-defined values must be entered for each application. The figure on page 11 illustrates these values and how they should be determined. It is important to remember that all distance values are measured from the sensor down.

**Blanking** Every ultrasonic transmitter has a dead zone near the transducer where it cannot measure level. In the U11 this is called the Blanking. The blanking is normally automatic but may be set to a specific value if required for the application. If the user defined blanking is shorter than the distance required by the automatic blanking, the U11 defaults to the automatic value.

**4 or 20mA Endpoints** The range of the U11 is determined by setting the distance from the transducer to the 4 and 20mA endpoints. An output of 20-4mA can be obtained by setting the 4mA point at the top and the 20mA point at the bottom. These values are entered in engineering units (feet or meters).

**Distance** The Echo Elimination\* feature requires a Distance value to be entered. This is the maximum distance to eliminate false echoes. When used, this value should be set slightly higher than the low level of the process so that it does not eliminate the bottom of the range.

\*USE THIS FEATURE **ONLY** WHEN REQUIRED!

**Empty Distance (EmpyDst)** The empty distance defines the farthest echo the U11 will accept. This eliminates the possibility of reading a secondary echo that appears to be below the bottom of the vessel. The Emptdst value should be set slightly farther than the end of the measured range so it will not blank out the bottom of the process.

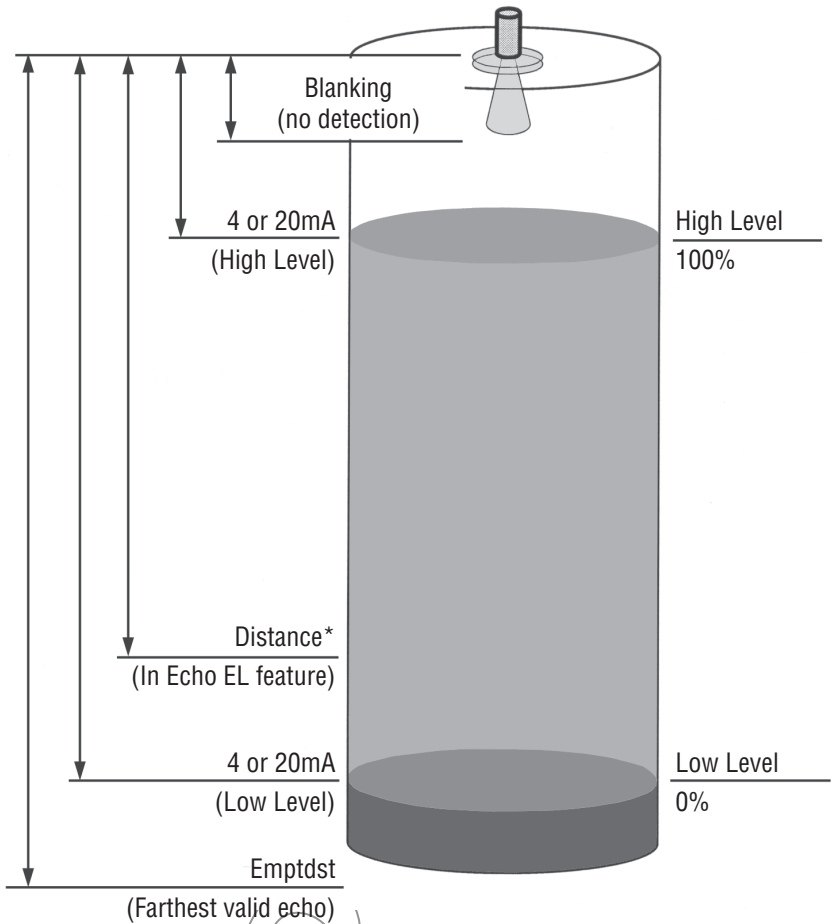

**NOTE: All values are measured and entered as a distance from the top down**

# Menu Structure



Normal operation screen.



Use the arrows at this screen to enter the unlock code setup in screen N below. The factory default is 0.



Use the arrows at this screen to change between the "Setup" and "Trim" menu. The Trim menu is used to fine-tune the 4 and 20mA endpoints, temperature compensation adjustment, add an offset or adjust the blanking if required.

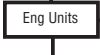

Select the engineering units for level measurement on the LCD display.

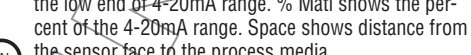

Select the display mode. Material shows level up from the low end of 4-20mA range. % Matl shows the percent of the 4-20mA range. Space shows distance from the sensor face to the process media.

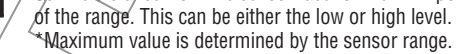

Set the distance from the sensor face for the 4mA point of the range. This can be either the low or high level. \*Maximum value is determined by the sensor range.

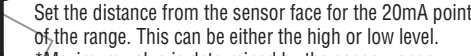

USE THIS FEATURE ONLY WHEN REQUIRED!! Set the distance from the sensor face for the 20mA point of the range. This can be either the high or low level. \*Maximum value is determined by the sensor range.

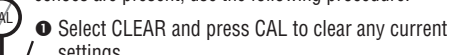

This allows elimination of unwanted echoes. When false echoes are present, use the following procedure:

- 1 Select CLEAR and press CAL to clear any current settings.
- 2 Lower the process level below all unwanted echoes.
- 3 Select SET to find and eliminate unwanted echoes, press CAL. The screen will display DISTANCE - enter a distance value slightly less than the current distance from the transducer face to the process material, press CAL.
- 4 The display will say STORE? N; use the up arrow to change to Y and press CAL. If you want to discontinue mapping, press CAL while the screen says N.
- 5 The screen will say MAPPING and run through a map routine. When complete, it will automatically return to RUN mode and begin searching for the process level.

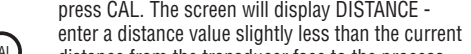

This is used to offset the output and display by the entered distance. The offset must be included as part of the maximum range. Damping slows the output reaction by averaging the level change over the time period selected.

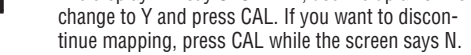

- |              |               |               |
|--------------|---------------|---------------|
| 1 = 1 second | 4 = 40 second | 7 = 10.4 min. |
| 2 = 5 second | 5 = 1.7 min.  | 8 = 21 min.   |
| 3 = 12 sec.  | 6 = 4.2 min.  | 9 = 42 min.   |

The U11 is programmed through the keypad buttons. CAL is used to enter the menus, access the options and accept the choices made. RUN is used to exit the menus and enter run mode. The "▲" and "▼" arrows are used to move between menu items and options. When using the arrow buttons to change numerical values, hold it down to make the numbers change faster.

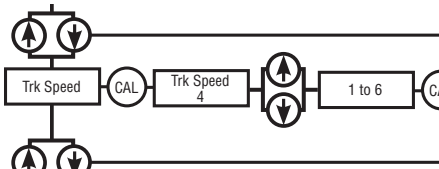

Select how fast the process is expected to move. Select a setting faster than the likely maximum rate.

- 1 = 0.3 ft./min.    3 = 1.5 ft./min.    5 = 9 ft./min.  
 2 = 0.6 ft./min.    4 = 4 ft./min.    6 = 16 ft./min.

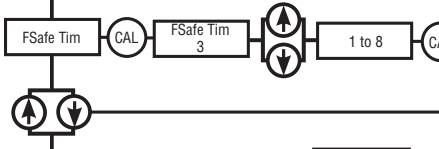

Fail Safe time is how long the unit will search after loss of echo before entering Fail Safe Mode.

- 1 = 23 sec.    4 = 1.5 min.    7 = 2.5 min.  
 2 = 46 sec.    5 = 2 min.    8 = 3 min.  
 3 = 1.2 min.    6 = 2.3 min.

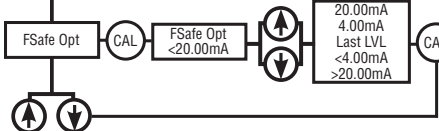

Select the desired output if the unit enters the Fail Safe Mode. Last LVL (last level) maintains the output at the time the unit enters Fail Safe.

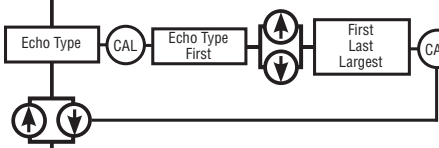

The preferred echo type can be the First to cross the threshold (prompted when First is chosen), the Last to cross the threshold or the Largest of all echoes detected. When First is chosen, a threshold value can be entered. This value is used as a value to augment the first echo. Example: 0% threshold = 100% echo size; 10% threshold = 110% echo size.

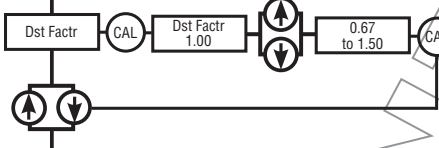

The D Factor compensates for differences in sound velocity in vapor mediums other than air. The default of 1.00 is for air (compensated for temperature).

$$D \text{ Factor} = \frac{\text{actual distance}}{\text{displayed distance}}$$

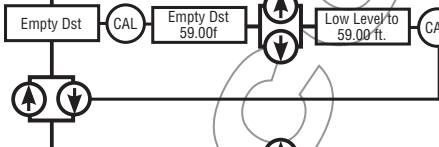
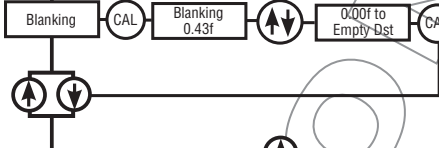

The empty distance is the farthest distance the unit should accept an echo from. This should be set slightly larger than the low level value.

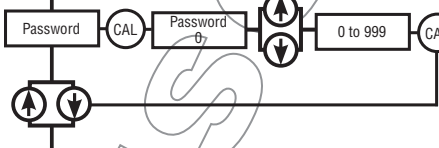

Enter a lock code to prevent unauthorized access to the program menus. 0 is the factory default.

Menu CAL Press the CAL button to switch from "Setup" menu to "Trim" menu.

RUN Press the RUN button to return to normal operation.

DISTANCE  
4.83 ft.



# Integral Electronics 20 kHz Transducer

FC Option

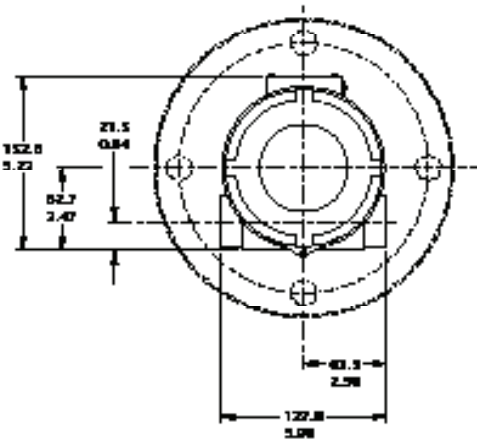
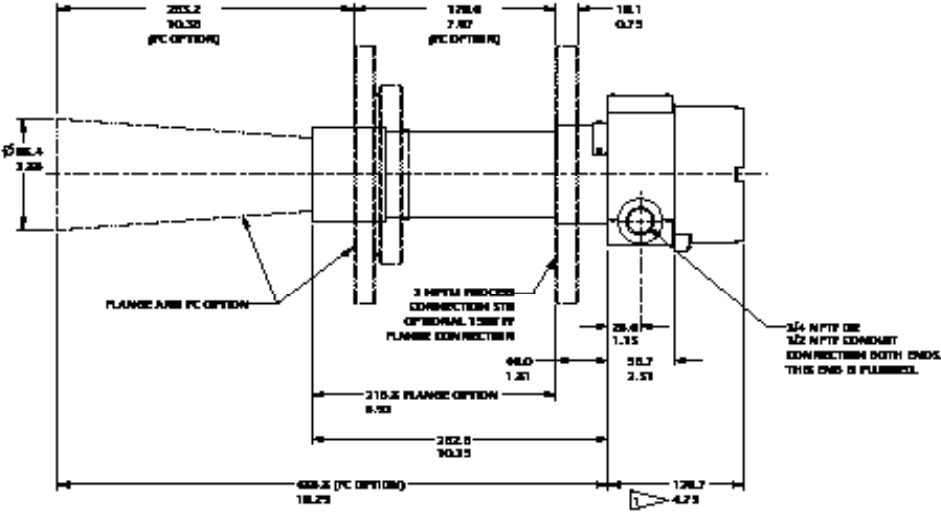

**NOTES**

1. SHINY GLASS END OF SHEATH. EXACTLY 0.52 INCHES (13.2 MM) FROM THIS DIMENSION FINE HOLDING WITH BLIND COVER.

Linear = mm/inches

Drawing 0390630



## Specifications

Frequency	Blanking Distance	Liquid/Slurry Range	Solids Range	Standard Mounting
30 kHz	12" (0.3m)	33 ft. (10m)	N/A	3" NPT

## Electronics

Input Voltage.....	23 to 30 VDC
Input Source .....	2-wire, loop power
Electronic Accuracy.....	±0.25% of maximum range
Maximum Value for Loop Resistor.....	(750Ω)
Display .....	2 x 8 digit alpha/numeric LCD display
Memory .....	Nonvolatile (no backup battery required)
Transmitter Operating Temperature.....	-4°F to 140°F (-20°C to 60°C)
Display Operating Temperature .....	14°F to 140°F (-10°C to 60°C)
Enclosure Material .....	Cast Aluminum

## Troubleshooting

When the unit is in normal operation, several diagnostic features can be accessed by pressing the  button. The top line of the display will scroll through two items detailed here as the  button is pushed. The bottom line of the display will continue to show the normal output. Accessing the diagnostic feature will not affect analog or relay outputs.

Datum	Description
GN	Gain being currently applied to the received echo. (Includes GR below.)
E	The actual distance currently being detected, regardless of damping or window location.

Printed in USA



sorinc.com

14685 West 105th Street, Lenexa, KS 66215 ■ 913-888-2630 ■ 800-676-6794 USA ■ Fax 913-888-0767